

Product Manual : Ver 1.00

SD-480-IV-US

Alpha Breeze



WARNING

KEEP ALL FLAME AND HEAT SOURCES AWAY FROM THIS TENT FABRIC

This tent is made with flame resistant fabric which meets CPAI-84 specifications. It is not fire proof. The fabric will burn if left in continuous contact with any flame source.

The application of any foreign substances to the tent fabric may render the flame resistant properties ineffective.

Thank you very much for purchasing a Snow Peak product. This product is a tent designed for camping. To use this product safely and correctly, please read these instructions carefully. After reading these instructions, keep this manual in a safe place for future reference. Although this product is expected to be complete and safe, please check that all accessory items are included before attempting to assemble the product. Practice assembling and handling the product in a safe location before using it while camping. If you find anything in the instruction manual that is difficult to understand, or if you find a defect with the product, stop using it immediately and contact the dealers where you purchased the product or Snow Peak Customer Service.

Set Contents

These parts are designed for set up in general conditions. To prepare for a variety of conditions, add stronger and longer pegs and ropes to your collection. Pegs, ropes, and tensioners may need to be replaced, so it is recommended that you always carry a spare.

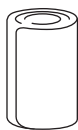

Fly
x 1



Inner Tent
x 1



A Pole x2
C Pole x1
Ridge Pole x1
Upright Pole x2



Duralumin Peg
(17cm (6.7") x 20)



Rope with Rope Tensioner
Forked 7m (22' 11") x2,
3.5m (11' 5") x1, 3m (9' 10") x2,
2m (6' 6") x4



Seam Sealer
x 1



Carry Bag
x 1

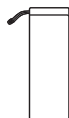

Pole Case
x 1



Peg Case
x 1



Instruction Manual
x 1

Frame Contents

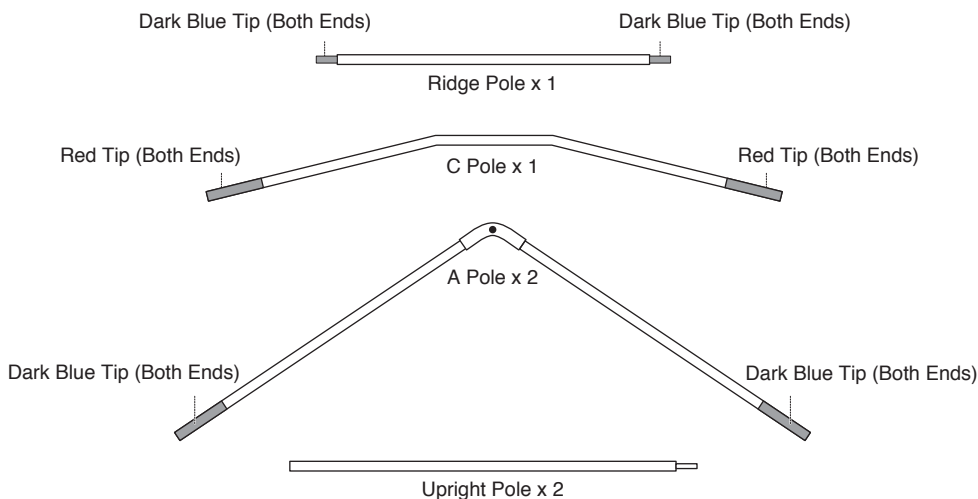

Safety Precautions Before use please read thoroughly to ensure safety and to avoid accidents.

⚠ DANGER Misuse could easily result in a serious accident or death.

- Do not use combustion-based heat sources such as lanterns, stoves or heaters, or open flames such as matches, candles, lighters or cigarettes, inside the tent. The use of such heat or light sources inside a small enclosed space is very dangerous and may result in fire, oxygen deficiency, or carbon monoxide poisoning.
- Do not keep fuel, or flammable items for replenishing the fuel, inside the tent.

⚠ WARNING Misuse could result in serious injury to the user.

- Pay close attention to the weather. If extreme weather is in the forecast, pack up camp and evacuate to a safe place.
- Do not bring heated items into the tent when they are at high temperatures.
- Inside the tent, very high temperatures may cause heatstroke. Pay close attention to the temperature, particularly when children are asleep inside the tent.
- Choose a flat, well-drained area with firm ground to pitch the tent. Choose an area where there is no chance of avalanches, landslides, wind gusts, or sudden flooding.

⚠ CAUTION Misuse could result in injury to the user and/or property damage.

- This product is not intended to be in permanent use. If the tent is left in the sun for long periods, the materials may fade in color or the fabric may deteriorate and lose strength. Do not leave the tent set up permanently.
- Sunlight can cause the surface of the Fly to heat up, potentially causing low-temperature burns.
- Do not assemble or use the tent close to a bonfire, fireworks, etc. Flying sparks can create holes in the tent fabric.
- Firmly hold the tent pole when assembling and disassembling the tent. Unexpected accidents may occur due to the Pole ends recoiling, etc, so ensure that the surroundings are safe, with no other people in the vicinity.
- Firmly fix the tarp to the ground using pegs and ropes.
- Since the Fly fabric is thin, it can be damaged if pulled too much. Please be careful.
- Be careful of the ropes and pegs when walking near the tent. You may catch your foot, which may result in an unexpected accident.
- There is a loop inside the tent to hang small items. Please do not hang items that are heavier than 1 kg(2 lb).

Name of Parts

[Fly]

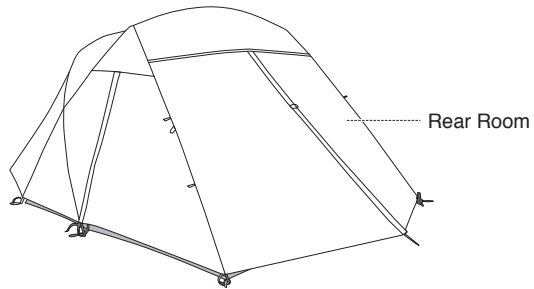
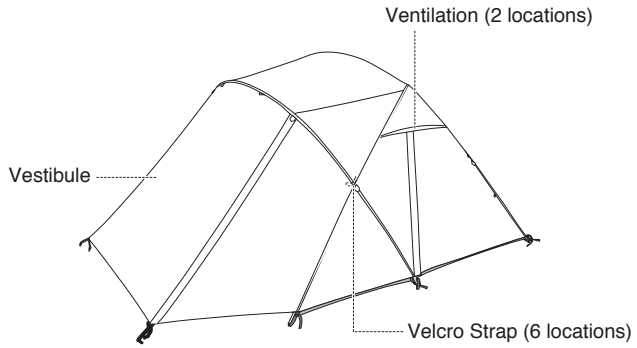

[Inner Tent]

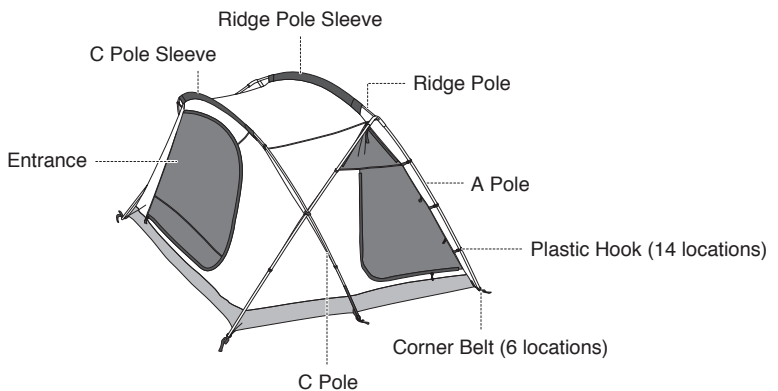

How to Attach Rope with Rope Tensioner to the Fly and Peg Down

Attach the Rope with Rope Tensioner to the Fly and peg it down as shown in the figure.

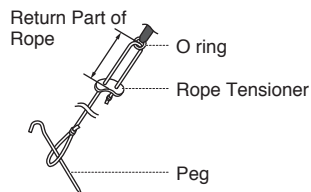
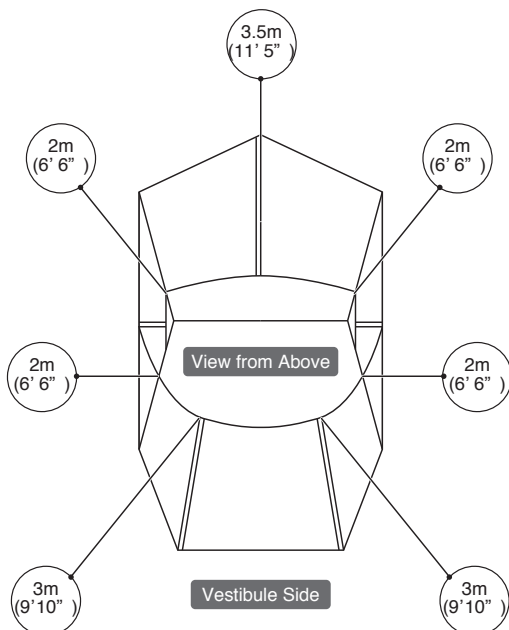

Attach as the return part with tensioner comes to the grommet side.

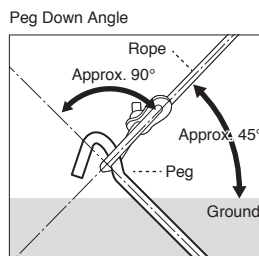

Peg it down as far as possible from the tent. The ideal peg position is when the rope is angled 45° to the ground. Be sure to insert the pegs at a 90° angle to the rope.

Preparations Before Use

A waterproofing treatment with seam taping has been applied to the stitching of the tent. However, the ventilator and fasteners on the Fly and a part of the bottom sheet cannot be treated with the seam tape due to their inherent design. Though capable during periods of normal rain, long spells of heavy or driving rain, or prolonged contact with water pools on the ground, may result in the penetration of water along the stitching. In such cases, the application of a seam sealer is recommended. Apply the seam sealer lightly on both sides along the stitching and dry completely. The seam sealer will cure with time. As the seam sealer wears off, re-apply as necessary. We do not provide a sealing service. However, to maintain the tent in its best condition, application of seam sealer by the user is highly recommended.

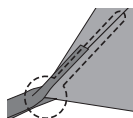

Please apply the seam sealer to the corners of the bottom of the tent. (4 locations)

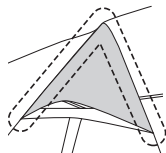

Please apply the seam sealer to the outside and inside surface of the back ventilator. (2 locations)

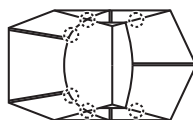

Apply the seam sealer to the outside of the Fly and the Velcro Tape. (6 locations)



Apply the seam sealer to the inside of the Fly, as well as the front and back of the Velcro Tape. (6 locations)

Set-Up Procedure

Follow the instructions below for setup and removal so you're prepared to use the tent in camp. Ensure all the accessories are included in the package. Forcible installation or removal may result in damage to the main unit or frames, or an accident. Please read thoroughly to understand the instructions.

Make sure the set contents are complete before going camping.

Make sure that two or more people take part in the set-up for safety.

- ① Spread out the Inner Tent so that the Bottom surface is spread evenly on the flat area.

* When it is windy, set up the tent so that the entrance side with the printed logo faces downwind.

If the entrance faces windward, wind and rain may enter, or the Main Body could be blown away or damaged.

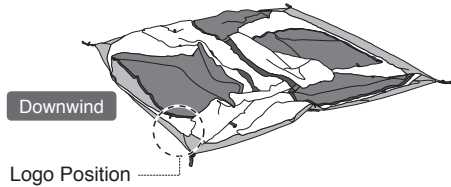

- ② Insert the Ridge Pole into the Sleeve with the dark blue tape located in the center of the Inner Tent.

* When inserting the Ridge Pole, please ensure the color of the tip of the Pole (dark blue) and the color of the Sleeve tape (dark blue) match.

* When inserting the Pole, be sure to push it in. If you pull the Pole, the joint may disconnect, and the setup will be inadequate.

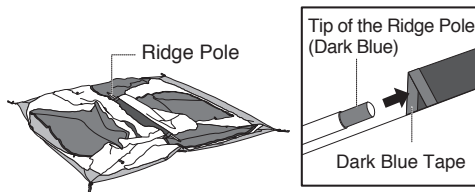

- ③ Assemble the A Pole to half its height and insert the tip of the Ridge Pole into the joint so that the dark blue sticker of the A Pole joint faces outward. Make sure the tip of the Ridge Pole is fully inserted into the joint and hook the Center Ring to the tip of the Ridge Pole.

* Please do not lift the Pole higher than necessary. Also, if there is a strong wind, wait until the wind stops before setting up. There is a danger that the A Pole, the joint of A Pole, and the Ridge Pole will be damaged.

* When hooking the Center Ring to the Ridge Pole, be careful not to twist the belt with the Center Ring.

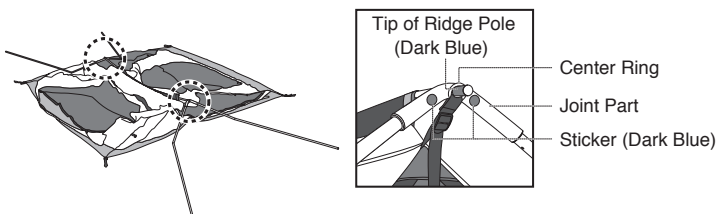

- ④ Assemble the A Pole on one side and insert the Ring Pin attached to the dark blue Corner Tape at the corner of the Inner Tent into both ends of the A Pole. Then, adjust the tension of the Center Ring tape.

- * When inserting the ring pin into the tip of A Pole, hold the tip of Pole firmly so that it does not move, and insert while being careful to avoid catching your fingers.
- * When inserting, please make sure that the color of the tip of the Pole (dark blue) matches the color of the corner tape (dark blue).
- * Be careful not to let the opposite side of the lifted A Pole recoil and hit nearby people or objects.

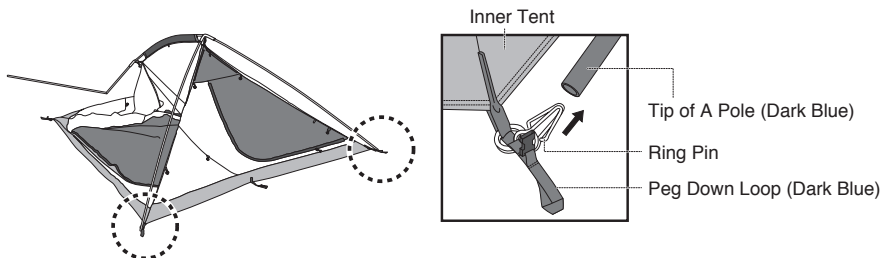

- ⑤ In the same way as ④, insert the Ring Pins into both ends of the A Pole on the opposite side and adjust the tension by pulling the belt of the Center Ring.



- ⑥ Assemble the C Pole and push it into the Inner Tent's Sleeve with the red tape until the center of the C Pole and the Sleeve are aligned. At the intersection of A Pole and C Pole, ensure the C Pole is on the outside.

- * When inserting, please ensure the color of the tip of the Pole (red) matches the color of the Sleeve tape (red).
- * When inserting the Pole, be sure to push it in. If you pull the Pole, the joint may come off and the setup will be inadequate.

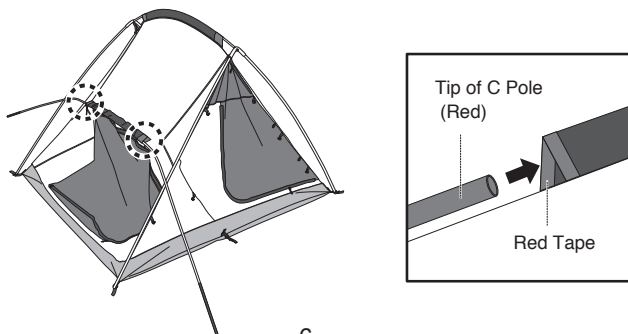

- 7 Insert the Ring Pins that are attached to the red Corner Tape on the Bottom of the Inner Tent into both ends of the C Pole.

* When inserting, please ensure the color of the tip of the Pole (red) matches the color of the Corner Tape (red).

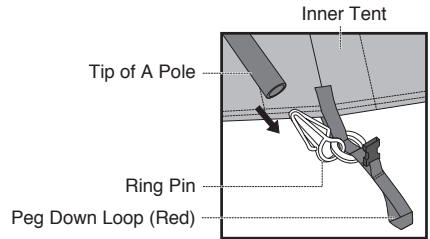
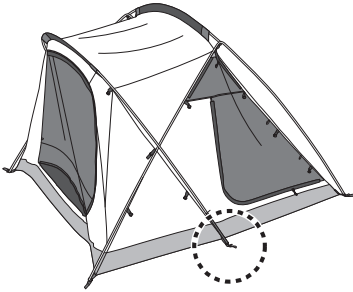

- 8 Please connect the Plastic Hook on the Inner Tent to each Pole. (14 locations)

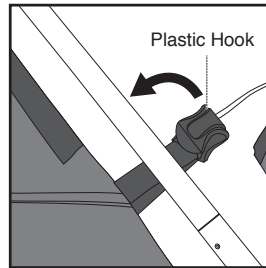
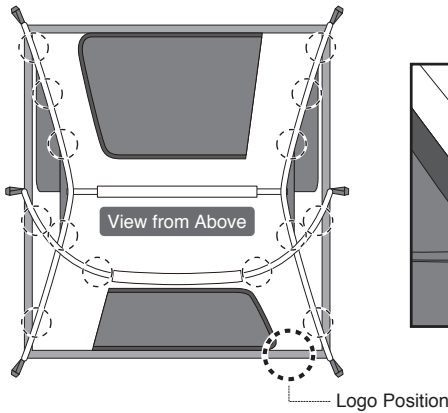

- 9 Wrap the Velcro Tape at the intersection of Pole A and Pole C around the Poles, as shown in the figure. (2 locations)

* Please wrap the Velcro Tape without twisting it.

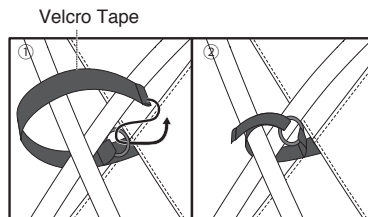

- 10 Spread the Fly in front of the Inner Tent so that the back of the Fly (the side without the logo printed on it) faces up. Then, align the Fly Entrance Panel with the panel that has the Inner Tent logo printed on it.

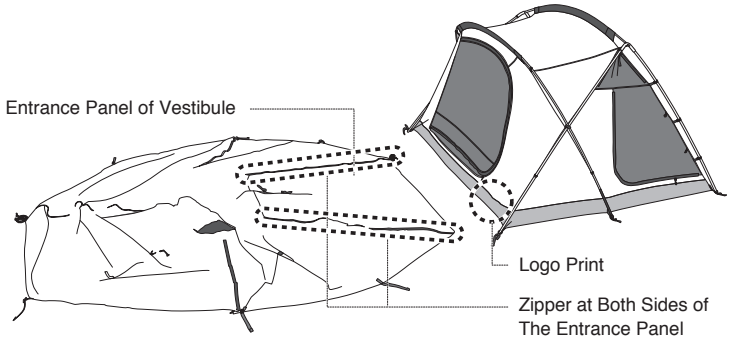

- 11 Connect the buckle at the tip of the dark blue Corner Tape of the Fly and the Inner Tent.
- * Be careful not to twist the Corner Tape.

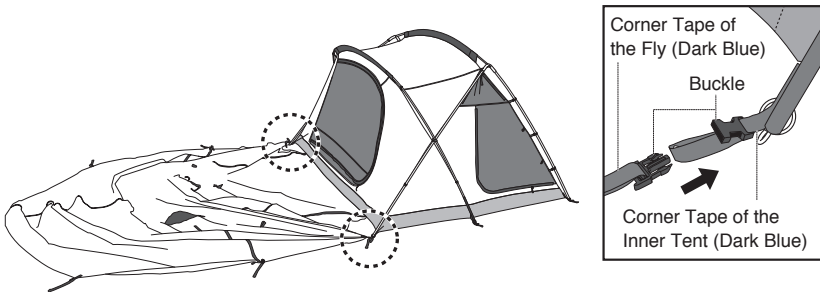

- 12 Stand on both sides of the Fly with 2 people and hold the corner farthest from Inner Tent on the Fly, and then put the Fly over Inner Tent. Then, adjust the position of the Inner Tent so that the Fly and the Fly panels match.



- 13 Secure the Fly by winding the slip prevention Velcro Tape inside the Fly around the Poles. (6 locations)

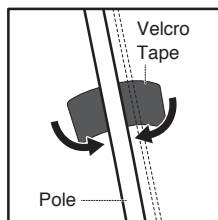
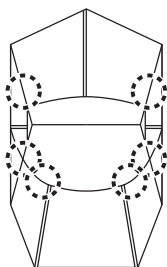

- 14 Connect the buckle at the tip of each Corner Tape of the Inner Tent and the Fly (4 locations). After connecting, pull the adjusting tape on all the buckles.

* When connecting, please ensure the color of each Corner Tape matches, and that Corner Tape is not twisted.

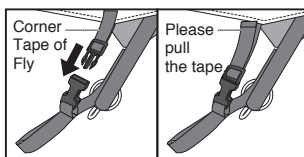
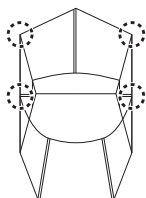

- 15 Insert the Peg into the Peg Down Loop at each corner and peg down in the order shown below while pulling outward. For areas 7 and 8, pull the tip of the Vestibule and insert a Peg into the rubber loop attached to the Vestibule (grey area) to secure it.

* If the Vestibule is pulled too much, the zipper will not close and it may be damaged. Please be careful not to pull too much.

* Please peg down with all the zippers closed, otherwise it may be difficult to close the door panel.

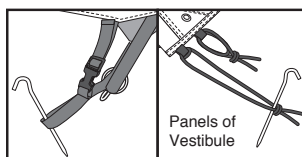
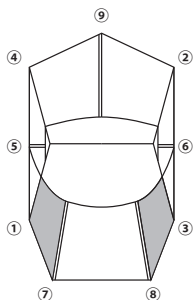

- 16 As shown in "How to Attach Rope with Rope Tensioner to the Fly and Peg Down" on page 4, attach each Rope with Rope Tensioner to the Fly, then pull it, secure it with the Peg and apply tension as needed.

* If the rope is pulled too much, the Fly will be over-burdened and there is a risk of damage. Please be careful not to pull too much.

How to set up the door panel

When using the Door Panel for extended shelter, insert the tip of the upright Pole into the Grommet at the end of the Door Panel, hook the center loop of the Forked Rope, and peg down as shown in the figure.

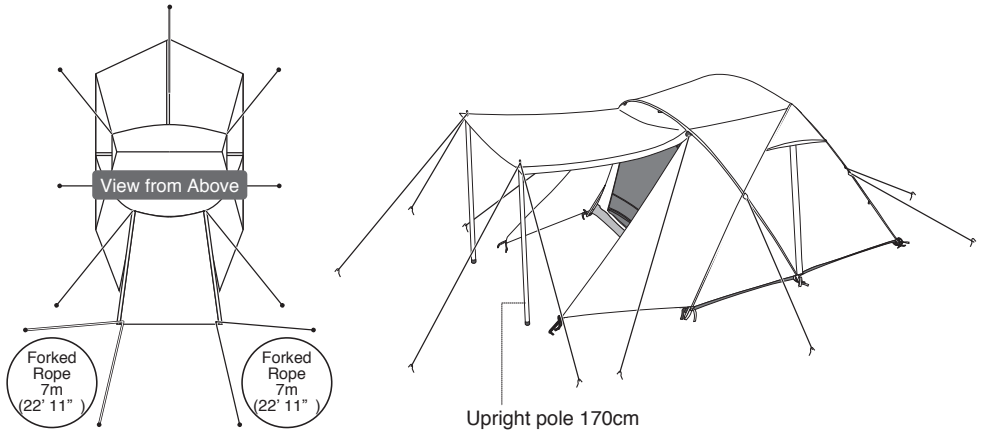

To prevent water accumulation in rainy weather, pass a rope through the Grommet attached to the center of the Door Panel, peg down the Rope, and lower the panel in a V-shape.

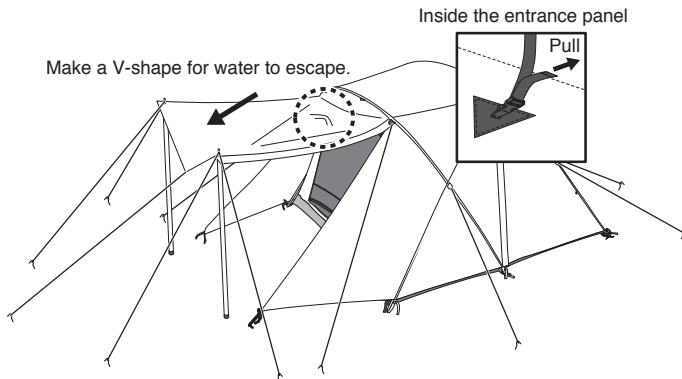

How to disassemble

Disassembling should be done in the reverse order of setup. Make sure there is nothing inside the Inner Tent or Fly before beginning. It will be easier to roll up the tent if you slightly open the zipper at the entrance of the Inner Tent.

- 1 Remove all the Pegs from the ground and gather all the Ropes with Rope tensioners.

* If the wind is strong, please do not remove the Pegs of the Tent Bottom on the windward side.



- 2 Remove the Corner Tape buckle and the Velcro Tape inside the Fly, then remove the Fly from the Inner Tent.



- 3 After removing all the Plastic Hooks and Velcro Tape attached to Pole, remove the Poles from the Inner Tent in this order: C Pole, A Pole, and Ridge Pole.
If you have any Inner Tent pegs left, please remove them all at this time.

* When removing the Pole from the Ring Pin, be sure to hold the Pole firmly. The Pole may recoil, and it is very dangerous.

* When removing the Pole from the Sleeve, make sure to check the surrounding area before pushing out.

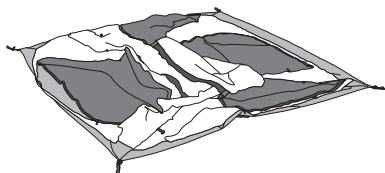

④ Fold the Fly and Inner Tent to fit the width of the Carry Bag as shown in the figure.

•How to fold the Inner Tent

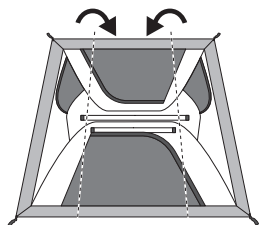

① Fold both ends inward toward the center.

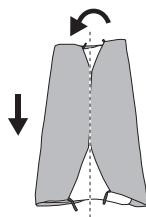

② Fold the Fly in half and roll it in the direction of the arrow.

•How to fold the Fly

Hold the Vestibule with 2 people, and let the Fly lay on the ground, so the center of the upper part of the Entrance Panel and the center of the upper part of the rear Entrance Panel are folded in half. Two people should grab the Fly, one should hold the center of the upper part of the Vestibule Entrance Panel, and the other should hold the center of the upper part of the rear room Entrance Panel, and then lay it on the ground, so that the Fly is folded in half at the center.

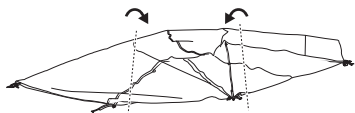

① Fold both ends inward toward the center.

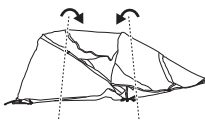

② Then repeat and fold both ends inward toward the center again.

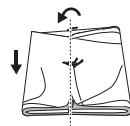

③ Fold it in half vertically and roll in the direction of the arrow.

⑤ Put the Poles and Pegs in the included cases and store them in the Carry Bag. Please be careful not to leave any Pegs behind. Please store the Pegs with the bent head facing down.



Water-Repellent and Waterproof Functions

- The fabric of the Fly is treated with a high-quality, water-repellent finish. However, the level of water-repellency and durability may vary slightly due to the characteristics of each material. In addition, the water repellency will deteriorate after long periods. When the water repellence decreases, please use a water-repellent spray purchased from your local outdoor gear retailer. When using such sprays, please follow the product's instructions.
- Materials with high waterproof capacity are used in this product. However, if the materials are in contact with pools of water on the ground for long periods, the water may be absorbed into the material.
- The PU coating may also be damaged by agricultural chemicals which cause an abnormal decrease in waterproof capabilities. Please note that the product cannot be covered under warranty if this is the cause of damage.
- The logo may peel off as a side-effect of using the water-repellent treatment.

Regarding the Effect of Ultraviolet Rays

- A UV protection treatment has been applied to the Fly material. The UV protection treatment will lessen the permeation of ultraviolet rays, which are harmful to humans, and also slow the deterioration of the Fly.
- *The UV protection treatment does not completely shield humans from ultraviolet rays or stop the deterioration of the material's strength.
- When the tent material is exposed to sunlight for long periods, color degradation or strength deterioration may occur. Do not leave the product assembled permanently.
- If the material deteriorates due to ultraviolet rays and is badly damaged, it may become irreparable.

Maintenance & Storage

- A combination of Polyester fabric is used for this product. Taking the material characteristics into consideration, we adopted processing and color patterns that will result in less color migration. However, depending on storage conditions, slight color migration may occur. Do not store the product while it is wet.
- Before storage, the product should be cleaned and dried sufficiently. If the product is stored when wet, the build-up of mold, bad odors, color migration, and material deterioration will occur. Dry the product sufficiently in a breezy and shaded area and clean the surface with a soft brush before storing.
- Clean and dry the surface of the Poles before storing. If stored when wet, corrosion may occur, resulting in strength deterioration. Keep the joints clean and apply a small amount of silicone lubricant; applying an excessive amount of lubricant will stain the cloth. Ensure that the cords inside the Poles are not pulled unnecessarily.
- When storing the Poles, please fold them from the center outwards. (Figure A)
- Using the zipper when it is covered with mud, sand or dust may cause wear or damage. Clean the zipper with a brush before use. Apply small amounts of silicone lubricant to the zipper regularly to ensure smooth movement. Do not apply excessive amounts of lubricant as it will leave stains on the cloth.
- Depending on the conditions during use, the tent material may deteriorate over a wide area, losing its durability and becoming irreparable.
- Seam tape is pressure-capped at a temperature setting that prevents damage to the PU coating. However, it may peel off as it is used repeatedly. If peeling is found, set an iron at a low temperature and reattach only the peeling sections. Be aware that excessive heat will discolor or accelerate the deterioration of the fabric. If the PU coating is peeled off completely, it may be impossible to repair.
- Sap cannot be easily removed. Do not set up this product under trees that frequently drop sap. If the sap is forcibly removed with a solvent, etc., the fabric or coating may be damaged.
- To maximize the longevity of this product, regularly check and maintain the product (including all accessories such as the pegs).

Figure A

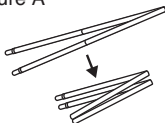

First Aid Solutions

As the Pole or the fabric of the product may be damaged due to unforeseen circumstances, always carry repair materials such as packing tape, vinyl tape, or a pipe that can be used as a splint. Always start repairs as soon as possible. If left damaged, the product may require extensive repairs or become impossible to fix.

- If the main fabric tears or has a hole, prevent the damage from spreading by attaching packing tape to the front and back of the damaged part of the main fabric, or disassemble the tent.
- If the Pole breaks, place a pipe to be used as a splint, on the Pole and attach it with tape. Or, disassemble the tent and pull out the Pole. (Figure B)

Figure B

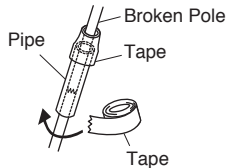

Regarding Warranty

The specifications of Snow Peak products are determined based on field testing and quality control, ensuring proper function and longevity of every product. If apparent defects in the manufacturing of the product are found, the defective product will be repaired or exchanged free of charge. Damages, as follows, are not covered under warranty.

1. Damage caused by improper use.
2. Material deterioration caused by age or the influence of ultraviolet rays.
3. Damage caused by modifications or rough handling.
4. Damage caused by unforeseen accidents.
5. Damage not caused by defects in the manufacturing process.
6. Damage caused by dust or rust.
7. Damage or defects caused when dismantling the product.
8. Damage and defects caused by dropping or other shocks to the product.
9. Defects, breakage, or deterioration of replaceable parts.
10. Damage caused by the use of the product in combination with other maker's products.

Regarding Repair

- If a professional repair is necessary, please contact the dealer where the product was sold or Snow Peak Customer Service.
- Please dry and clean the product before sending it for repair.
- Please stick a memo onto the damaged area of the product. In the memo, include details explaining the circumstances that led to the damage.
- The cost of repair will be determined as follows:
 1. If the damage is subject to warranty, transportation cost (both ways) and repair cost will be covered by Snow Peak.
 2. If the damage is not subject to warranty, transportation cost (both ways) and repair cost will be covered by the customer.

Specifications

- Material: Fly / 75D Fire-resistant Polyester Taffeta, PU coating, Waterproof rating: 1,800mm minimum, Water-repellent finish, UV protection treatment; Inner Wall / 68D Fire-resistant Polyester Taffeta; Bottom / 300D Fire-resistant Polyester Oxford, PU coating, Waterproof rating: 5,000mm minimum; Pole / Duralumin A6061 (Φ16mm (0.6") + Φ13mm (0.5"))
- Contents: Tent; A Pole (x2); Ridge Pole (x1); C Pole (x1); Upright Pole (x2); Duralumin Peg 17cm (6.7") x20; Rope with Rope Tensioner (Forked 7m (22' 11") x2, 3.5m (11' 5") x1, 3m (9' 10") x2, 2m (6' 6") x4); Seam Sealer; Carry Bag; Pole Case; Peg Case
- Carry Bag size: 64x23x27(h)cm (25.1"x9"x10.6")
- Weight: 11kg (24.2lbs)

- Capacity: 3-5 persons

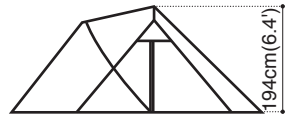

(Indoor height 186cm (6.1'))

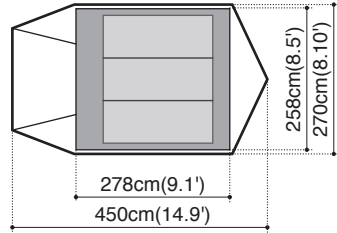

Snow Peak USA, Inc.

404 NW 23rd Ave., Portland, OR 97210, USA
Tel. +1-503-697-3330

www.snowpeak.com
Instagram @snowpeakusa

MADE IN CHINA