

---

# TomTom ONE

# 1. What's in the box

## 1 Your TomTom ONE

(Maps for US & Canada are pre-loaded in internal memory)

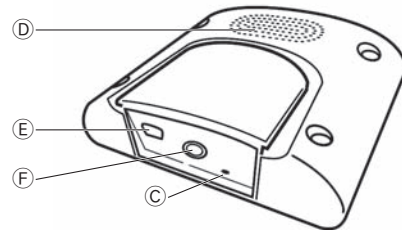
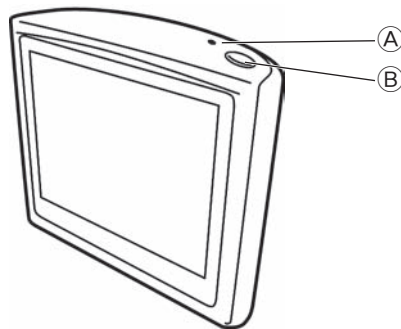

- Ⓐ Charging light
- Ⓑ On/Off button
- Ⓒ Reset button
- Ⓓ Speaker
- Ⓔ USB connector
- Ⓕ RDS-TMC connector

## 2 Car charger



## 3 Documentation pack

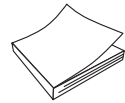

## 4 Windshield Holder



## 5 USB cable

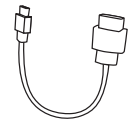

## 6 Adhesive disk for windshield mount

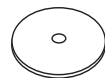

## 2. Before You Start...

---

### Switching on and off

To switch your TomTom ONE on or off, press and hold the On/Off button for 2 seconds. The first time you switch on, it may take a short while for your device to start.

---

**Note:** *In rare cases, your ONE may not start correctly. If this happens, press the reset button, then switch on the device again.*

---

### Setting up

To set up your TomTom ONE you need to answer a few questions by tapping the screen.

---

**Important:** Take care to select the correct language, since the language you choose will be used for all menus and written instructions.

---

### Battery notes

For information on connecting your computer, see **Using TomTom HOME** (43).

---

**Note:** *Your TomTom ONE uses a small amount of battery power to remember the last screen being shown when the device is switched off.*

*If you do not charge your ONE for a prolonged period of time, the next time you start your ONE it will show the default starting screen. All other device settings will still be maintained.*

---

### Improving reception

If your TomTom ONE takes longer than 5 minutes to find your current position, make sure that the device is in an open space away from tall objects such as buildings or trees.

When you connect your TomTom ONE to your computer, you can use TomTom HOME to download information about GPS satellite positions during the next 7 days. This helps your ONE to find your position faster.

---

**Important:** Some vehicles have heat reflective shielding in the windscreen. This may prevent your ONE from locating your current position.

---

## Windshield Holder

Use the windshield holder to install your TomTom ONE inside your car.

To attach the holder, press the suction cup firmly to the windshield in your car, in an area of the windshield where the glass is flat.

Make sure that both the holder and your windshield are clean and dry before you attach the holder. Place the holder so that it does not interfere with your view of the road.

## Take care of your TomTom ONE

Never leave your TomTom ONE or accessories in view when you leave the car or they may become an easy target for thieves.

You can set a password for your TomTom ONE which must be entered every time you start your ONE. For more information, see **Using TomTom HOME** (43).

It is important to take care of your ONE.

- Your ONE is not designed for use in extreme temperatures and any such exposure may cause permanent damage.
- Do not open the casing of your ONE under any circumstances. Doing so may be dangerous and will invalidate the warranty.
- Wipe or dry the screen of your ONE using a soft cloth. Do not use any liquid cleaners.

### 3. Driving View

When your TomTom ONE starts, you are shown the Driving View along with detailed information about your current location.

Tap the center of the screen at any time to open the Main Menu.

---

**Note:** The Driving View is shown in black and white until your ONE locates your current position.

---



- Ⓐ Tap + and - to zoom in and out.
- Ⓑ Your current position.
- Ⓒ The name of the next major road or road sign information, if applicable.
- Ⓓ Navigation instruction for the road ahead.  
Tap this area to repeat the last spoken instruction and to change the volume.
- Ⓔ The name of the street you are on.
- Ⓕ Information about your trip such as trip time, remaining distance and arrival time.  
To select what will be shown, tap **Status bar preferences** in the **Preferences** menu.
- Ⓖ GPS signal strength.
- Ⓗ Traffic bar - requires an RDS-TMC Traffic Receiver (available as an accessory).

To set up Traffic information, tap the Traffic bar to open the Traffic menu or tap TomTom **Traffic** in the Main Menu.

## 4. Making your first trip

Planning a route with your TomTom ONE is easy. To plan your first route, follow the steps below.

---

**Important:** You should always plan your journey before you start driving. It is dangerous to plan a route while driving.

---

1. Tap the screen to bring up the main menu.

---

**Note:** The buttons on your ONE are shown in full color unless a button is currently unavailable. For example, the button named **Find alternative...** in the Main Menu is not available until you have planned a route.

---

2. Tap **Navigate to...**



3. Tap **Address**.

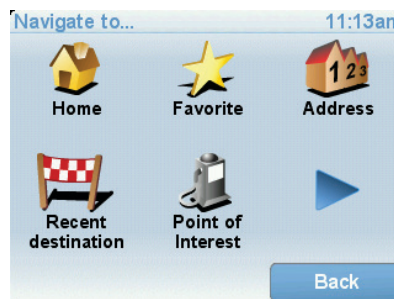

When you enter an address, you can choose from the following options:

- **City center** - tap this button to set your destination as the center of a city or town.
- **Street and house number** - tap this button to set an exact address as your destination.
- **ZIP code** - tap this button to enter a ZIP code as your destination.
- **Cross street or intersection** - tap this button to set your destination as the point where two streets meet.

For your first trip, we will enter an exact address.

4. Tap **Street and house number**.



---

**Note:** When planning a trip for the first time your ONE asks you to choose a state or country. Your choice is saved and used for all routes you plan.

You can change this setting at any time by tapping the state symbol or country flag.

---

5. Start to type the name of the town where you want to go.



As you type, the names of the towns that match what you have typed are shown. When your destination appears in the list, tap the name of the town to set the destination.

6. Start to type the name of the street and select it when it is shown.

As with the name of the town, the names of the streets that match what you have typed are shown. When your destination appears in the list, tap the name of the street to set the destination.

7. Now enter the house number of your destination and then tap **Done**.

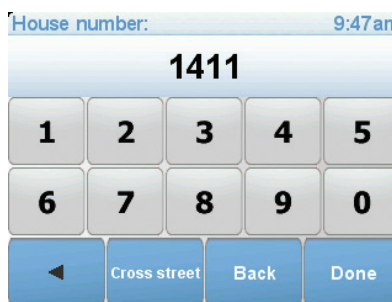

8. Your ONE asks if you need to arrive at a particular time. For this exercise, tap **NO**.

The route is calculated by your ONE.

9. When the route has been calculated, tap **Done**.

Your ONE will immediately begin to guide you to your destination, using both spoken instructions and on-screen directions.



## Arrival times

When you plan a route, your TomTom ONE asks you if you need to arrive at a particular time.

Tap **YES** to enter a preferred arrival time.

Your ONE calculates your arrival time and shows you whether you will arrive on time.

You can also use this information to work out when you need to leave. If your ONE shows that you will arrive 30 minutes early, you can wait and leave in 30 minutes time, rather than arrive early.

Your arrival time is constantly recalculated during your trip. The status bar shows whether you will arrive on time or if you are going to be late, as shown below:

**+55 min**

You will arrive 55 minutes before the arrival time you entered.

If the estimated arrival time is more than five minutes before the time you entered, it is shown in green.

**+3 min**

You will arrive 3 minutes before the arrival time you entered.

If the estimated arrival time is less than 5 minutes before the time you entered, it is shown in yellow.

**-19 min**

You will arrive 19 minutes late.

If the estimated arrival time is later than the time you entered, it is shown in red.



**Status bar preferences**

Tap **Status bar preferences** in the Preferences menu, to enable or disable arrival time notifications.

Select the required options on the first menu screen and then tap **Done**.

To enable arrival time notifications, select **Show leeway to arrival time**.









To disable arrival time notifications, unselect **Show leeway to arrival time**.



## What are the other navigation options?

When you tap **Navigate to...**, you can set your destination in many ways, not just by entering the address. The other options are listed below:

---

 <b>Home</b>	<p>Tap this button to navigate to your Home location.</p> <p>You will probably use this button more than any other.</p> <p>For information about setting your Home location, see <b>Change Home location</b> (28).</p>
 <b>Favorite</b>	<p>Tap this button to select a Favorite as your destination.</p> <p>For more information about Favorites, see <b>Favorites</b> (18).</p>
 <b>Address</b>	<p>Tap this button to enter an address as your destination.</p>
 <b>Recent destination</b>	<p>Tap this button to select your destination from a list of places you have recently used as destinations.</p>
 <b>Point of Interest</b>	<p>Tap this button to navigate to a Point of Interest (POI).</p> <p>For more information about POIs and navigating to a POI, see <b>Points of Interest</b> (23).</p>
 <b>GPS position</b>	<p>Tap this button to select your GPS position, as your destination.</p> <p>For more information about GPS, see <b>Global Positioning System (GPS)</b> (42).</p>
 <b>Point on map</b>	<p>Tap this button to select a point on the map as your destination using the map browser.</p> <p>For more information about the map browser, see <b>Driving View</b> (5).</p>
 <b>Latitude Longitude</b>	<p>Tap this button to enter a destination using latitude and longitude values.</p>
 <b>Position of last stop</b>	<p>Tap this button to select your last recorded position, as your destination.</p> <p>For more information about the GPS, see <b>Global Positioning System (GPS)</b> (42).</p>

---

## Planning a route in advance

You can also use your ONE to plan trips in advance by selecting both your starting point and your destination. You could, for example, do the following:

- Find out how long a trip is going to take before you start.
- Check the route of a trip you are planning.
- Check a route for someone who is coming to visit you so you can explain the route to them.

To plan a route in advance, follow these steps:

1. Tap the screen to bring up the main menu.
2. Tap the arrow button to move to the next menu screen and tap **Prepare route**.



### Prepare route

3. Select the starting point for your trip in the same way that you would select your destination.
4. Set the destination for your trip.
5. Choose the type of route that should be planned.
  - **Fastest route** - the route which takes the least time.
  - **Shortest route** - the shortest distance between the locations you set. This may not be the quickest route, especially if the shortest route is through a town or city.
  - **Avoid freeways** - a route which avoids freeways.
  - **Walking route** - a route designed for making the trip on foot.
  - **Bicycle route** - a route designed for making the trip on a bicycle.
  - **Limited speed** - a route for a vehicle which can only be driven at a limited speed. You have to specify the maximum speed.
6. Your TomTom ONE plans the route between the two locations you selected.

### More information about a route

To find out about your route in detail, tap the **Details** button on the route summary screen.

You can then select from the following options:



#### Browse as text

Tap this button for a list of all the turn instructions on the route.

This is very useful if you need to explain a route to someone else.



#### Browse as images

Tap this button to see each turn in the trip. Tap the right and left arrows to move forwards and backwards through the trip.

Tap the screen to turn off the 3D display and view the map from above.



#### Browse map of route

Tap this button to see an overview of the route using the map browser.

For more information about the map browser, see **Driving View (5)**.



Tap this button to watch a demo of the trip. You can interrupt the demo at any time by tapping the screen.



Tap this button to open the route summary screen.

---

## 5. Finding alternative routes

---

Once you have planned a route, you may want to change something about the route, without changing your destination.

### Why change the route?

Maybe for one of these reasons:

- You can see a roadblock or a line of traffic ahead.
- You want to travel via a particular location, to pick someone up, stop for lunch or fill up with gas.
- You want to avoid a difficult intersection or a road you don't like.



Tap **Find alternative...** in the Main Menu to change the route that is currently planned.

Then tap one of the options below.



Tap this button to calculate an alternative to the route already planned.

Your ONE will look for another route from your current location to your destination.

If you decide you would prefer to use the original route after all, tap **Recalculate original**.

#### Why would I need to do this?

Apart from the roads near your position and near your destination, the new route will use totally different roads to reach your destination. This is an easy way of calculating a totally different route.



Tap this button if you can see a roadblock or a line of traffic ahead. You then have to choose how much of the route ahead you want to avoid.

Choose from the different options: 100m, 500m, 2000m, 5000m. Your ONE will recalculate your route avoiding the section of the route for the distance you selected.

Don't forget that once a new route is calculated, you may have to turn off the road you are on very soon.

If the roadblock suddenly clears, tap **Recalculate original** to return to your original route.



**Travel via...**

Tap this button to change your route so that it passes a particular location, perhaps to pick someone up on the way.

You choose the location you want to pass in the same way as you choose a destination. So you can select from all the same options: for example, **Address, Favorite, Point of Interest** and **Point on map**.

Your ONE will calculate a new route to your destination that passes the location you chose.

---



**Recalculate original**

Tap this button to return to the original route without deviations to avoid roadblocks or traveling via particular locations.

---



**Avoid part of route**

Tap this button to avoid a part of the route. Use this button if you see that your route includes a road or junction you don't like, or which is well-known for traffic problems.

You then choose the road you want to avoid from a list of the roads on your route.

---



**Minimize traffic delays**

Tap this button to recalculate your route so that it avoids traffic problems as much as possible. Your ONE will check if there are any traffic problems on your route and work out the best route to avoid the problems.

---

## 6. Sounds and voices

---

The sound on your TomTom ONE is used for features such as:

- Spoken instructions
- Warnings

### How do I change the volume level?

You can change the volume in three ways:

- Tap the bottom left hand area of the Driving View. The last spoken instruction is repeated and the volume level is shown.

Move the volume slider to adjust the volume.

- In the Main Menu, tap **Change preferences**, then tap **Volume preferences**.

Tap **Test** to check your changes.

### Changing the volume automatically

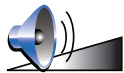

**Volume preferences**

Your TomTom ONE can change the volume automatically.

1. In the Main Menu, tap **Change preferences**.
2. Tap **Volume preferences**.
3. Select **Link volume to car speed**.
4. Tap **Done**.

### Selecting a voice



**Change voice**

To change the voice being used by your TomTom ONE, tap **Change voice** in the Preferences menu and select a voice from the list.

## 7. Help me!

---

Help me! provides an easy way to navigate to emergency services centers and other specialist services and contact them by phone.

For example, if you are involved in a car accident, you could use Help me! to call the nearest hospital and tell them your exact location.

### How do I use Help me! to call a local service?

You can use Help me! to find and make contact with a service center.

When you select a service center, your current location and the phone number of the POI are shown.

To use Help me! to locate a service center, contact the center by phone and navigate from your current location to the center, do the following:

1. Tap the screen to bring up the main menu.
2. Tap **Help me!**
3. Select the type of service you require, for example, Nearest hospital.
4. Select a center from the list; the nearest is shown at the top of the list.

Your ONE shows the location of the service center on the map and the contact details.

5. To navigate your way to the center on foot, tap **Walk there**.

Your ONE starts guiding you to your destination.

## Options

---



### Phone for help

Use your TomTom ONE to find the location of a service and the contact details.

- **Emergency services**
- **Emergency breakdown services**
- **Nearest police station**
- **Nearest doctor**
- **Nearest hospital**
- **Nearest public transport**
- **Nearest car repair services**
- **Nearest dentist**
- **Nearest pharmacy**
- **Nearest vet**

---

***Note:** In some countries, information may not be available for all services.*

---



### Drive to help

Use your TomTom ONE to navigate your way by road to a service center.

- **Nearest car repair services**
- **Nearest hospital**
- **Nearest doctor**
- **Nearest police station**
- **Nearest pharmacy**
- **Nearest dentist**

---

***Note:** In some countries, information may not be available for all services.*

---



### Walk to help

Use your TomTom ONE to navigate your way on foot to a service center.

- **Nearest gas station**
- **Nearest public transport**
- **Nearest police station**
- **Nearest pharmacy**
- **Home**
- **Nearest doctor**

---

***Note:** In some countries, information may not be available for all services.*

---



### Where am I?

Your TomTom ONE shows your current location.

You can then tap **Phone for help** to select the type of service you want to contact.

---





**First Aid  
Guide**

Tap this button to read the British Red Cross First Aid guide.



**Other guides**

Tap this button to read a selection of useful guides.

---

## 8. Favorites

---

### What are Favorites?

Favorites are places that you often visit. You can create Favorites so that you don't have to enter the address every time you want to navigate there.

They don't have to be places you especially like, just useful addresses.

### How can I create a Favorite?

From the Main Menu, tap **Add Favorite**.

---

**Note:** The button **Add Favorite** may not be shown on the first page of the Main Menu. Tap the arrow to open other pages in the Main Menu.

---

You can then select the location of the Favorite from the list below.

Give your Favorite a name that is easy to remember. Your ONE will always suggest a name, usually the address of the Favorite. To enter the name, just start typing. You don't have to delete the suggested name.



Home

You can set your Home location as a Favorite.



Favorite

You cannot create a Favorite from another Favorite. This option will always be unavailable in this menu.

To rename a Favorite, tap **Manage Favorites** in the Preferences menu.

For more information, see **Manage Favorites (28)**.



Address

You can specify an address to be a Favorite. When you enter an address, you can choose from four options.

- **City center**
  - **Street and house number**
  - **ZIP code**
  - **Crossing or intersection**
-



**Recent destination**

Select a Favorite location from a list of places you have recently used as destinations.



**Point of Interest**

You can add a Point of Interest (POI) as a Favorite.

**Does it make sense to do this?**

If you visit a POI you particularly like, for example a restaurant, you can add it as a Favorite.

To add a POI as a Favorite, tap this button, then do the following:

1. Narrow your choice of POIs by selecting the area where the POI is.

You can select one of these options:

- **POI near you** - to search from a list of POIs near your current position.
- **POI in city** - to choose a POI in a particular town or city. You have to specify a town or city.
- **POI near Home** - to search from a list of POIs near your Home location.

If you are currently navigating to a destination, you can also select from a list of POIs which are on your route or near your destination. Choose one of these options:

- **POI along route**
- **POI near destination**

2. Select the category of POI.

Tap the category of POI if it is shown or tap the arrow to choose from the complete list.

Tap **Any POI category** to search for a POI by name.

For more information about POIs, see **Points of Interest (23)**.



**My location**

Tap this button to add your current position as a Favorite.

For example, if you stop somewhere interesting, while you are there you can tap this button to create the Favorite.



**Point on map**

Tap this button to create a Favorite using the map browser.

Select the location of the Favorite using the cursor, then tap **Done**.

For more information about the map browser, see **Browse map (21)**.



**Latitude Longitude**

Tap this button to create a Favorite by entering latitude and longitude values.

---



Tap this button to select your last recorded position as your destination.

For more information about the GPS, see **Global Positioning System (GPS)** (42).

---

### How can I use a Favorite?

You will normally use a Favorite as a way of navigating to a place without having to enter the address. To navigate to a Favorite, do the following:

1. Tap the screen to bring up the main menu.
2. Tap **Navigate to...**
3. Tap **Favorite**.
4. Select a Favorite from the list.

Your ONE calculates the route for you.

5. When the route is calculated, tap **Done**.

Your ONE will immediately start guiding you to your destination with spoken instructions and visual instructions on the screen.

### How many Favorites can I create?

You can create up to 48 Favorites. If you want to add more than 48, we suggest that you make some POI categories and add some of your Favorites as POIs.

For more information about POIs, see **Points of Interest** (23).

### How can I delete a Favorite?

1. Tap the screen to bring up the main menu.
2. Tap **Change preferences** to open the Preferences menu.
3. Tap **Manage Favourites**.

---

**Tip:** Tap the arrow to move to the next page.

---

4. Tap the Favorite you want to delete.
5. Tap **Delete**.

### How can I change the name of a Favorite?

1. Tap the screen to bring up the main menu.
2. Tap **Change preferences** to open the Preferences menu.
3. Tap **Manage Favorites**.

---

**Tip:** Tap the arrow to move to the next page of buttons.

---

4. Tap the Favorite you want to rename.
5. Tap **Rename**.

## 9. Browse map

To look at the map in the same way as you might look at a traditional paper map, tap **Browse map** in the Main Menu.

You can move the map by touching the screen and moving your finger across the screen.



Ⓐ The scale bar

Ⓑ Your current position.

Ⓒ GPS button

Tap this button to center the map on your current position.

Ⓓ Options

Ⓔ The cursor

Ⓕ The Find button

Tap this button to find specific addresses.

Ⓖ The Cursor button

Tap this button to navigate to the cursor position, make a Favorite of the cursor position, or find a Point of Interest near the cursor position.

Ⓗ The zoom bar

Zoom in and out by moving the slider.

### Cursor button

You can use the map to find addresses and Points of Interest (POIs), for example, restaurants, train stations and gas stations.

Tap the cursor button then tap one of the following buttons:



Tap this button to navigate to the cursor position. Your ONE will calculate the route.



Tap this button to bring the location currently highlighted by the cursor to the center of the screen when looking at the map.



Tap this button to create a Favorite at the cursor position.

For more information about Favorites, see **Favorites (18)**.

---

## 10. Points of Interest

---

Points of Interest or POIs are useful places on the map. Here are some examples:

- Restaurants
- Hotels
- Museums
- Parking garages
- Gas stations

### Showing POIs on the map

1. Tap **Show POIs on map** in the Preferences menu.



2. Select the POI categories to display on the map.

Tap **Find** to search for a POI by name.

3. Tap **Done**.

The POIs you have selected are shown as symbols on the map.

### Navigating to a POI

You can use a POI as your destination. For example, if you are traveling to an unfamiliar city, you could choose a POI to help find a parking garage.

1. Tap the screen to bring up the main menu.
2. Tap **Navigate to...** in the Main Menu.
3. Tap **Point of Interest**.
4. Tap **POI in city**.
5. Narrow your choice of POIs by selecting the area where the POI is located.

You can select one of these options:

- **POI near you** - to choose from a list of POIs near to your current location.
- **POI in city** - to find a POI in a particular town or city.
- **POI near Home** - to choose from a list of POIs near to your Home location.

You can select from a list of POIs which are along your route or close to your destination. Choose from one of these options:

- **POI along route**
- **POI near destination**

6. Type the name of the town you want to visit and select the town when it appears in the list.

7. Tap **Parking garage**.

8. Select the category of POI:

Tap **Any POI category** to search for a POI by name.

Tap the category of POI, if it is shown.

Tap the arrow to choose from the complete list of categories. Select the category from the list or start to type the name of the category and select it when it appears in the list.

9. Select a parking garage. The distance listed next to each POI is the distance from the city center.

10. From the list of POIs shown, select the POI you want to navigate to.

The table below explains the distances listed next to each POI.

POI near you	Distance from your current location
POI in city	Distance from the city center
POI near Home	Distance from your Home location
POI along route	Distance from your current location
POI near destination	Distance from your destination
Last POI	Distance to the last POI you visited

If you know the name of the POI, tap **Find** and type the name. Select it from the list when it is shown.

11. Select a parking garage. The distance listed next to each POI is the distance from the city center.

Once you have selected a POI, the route to the POI is calculated by your TomTom ONE.

The route to the POI is then calculated by your TomTom ONE.

## How can I set warnings for POIs?

1. Tap the screen to bring up the main menu.
2. Tap **Change preferences**.
3. Tap **Manage POIs**.

---

**Note:** The **Manage POIs** button is only available when all menu buttons are shown. To show all menu buttons, tap **Show ALL menu options** in the Preferences menu.

---



4. Tap **Warn when near POI**.



Tap this button to receive a warning when you travel near to the location of a POI.

5. Select the category of POI you want to be warned about.

Select the category from the list or start to type the name of the category and select it when it is shown in the list.

6. Set how close the POI should be when you receive a warning.

7. Choose the warning sound for the category of POI you selected.

## 11. Preferences

---

You can change the way your TomTom ONE looks and behaves.

Tap **Change preferences** in the Main Menu.

### Use night colors / Use day colors



**Use night colors**

Tap this button to reduce the brightness of the screen and show darker colors on the map.

#### When should I use this?

When it's dark, it is easier to see the screen if the display on your ONE is not brightly lit.



**Use day colors**

To change back to a brighter screen showing brighter colors on the map, tap **Use day colors**.

### Show POI on map



**Show POI on map**

Tap this button to set which categories for the Points of Interest (POIs) should be shown on the map.

Select the POIs that you want to see on the map from the list.

When you select a POI, it is shown on the map using the symbol you can see next to each category in the list.

To find a POI category quickly, tap **Find**, then start to type the name of the POI category. As soon as the category is shown in the list, you can select it.

For more information about POIs, see **Points of Interest (23)**.

## Safety preferences



Safety preferences

Tap this button to set the following safety preferences:

- **Hide most menu options while driving**
- **Suggest driving breaks**
- **Show safety reminders**
- **Warn when near places of worship or schools**
- **Warn when driving faster than allowed**
- **Warn when driving faster than a set speed**
- **Warn not to leave the device in the car**

If you select one or more of the warnings, you will also be asked to select a sound to be played whenever a warning is displayed.

Select whether or not your TomTom ONE should warn you about which side of the road you should be driving on.

Decide if you want the map display to be turned off in special circumstances and press **Done**.

### What happens when I use the Turn off map display option?

When you turn off the map display, instead of seeing your position on a map in the Driving View, you will only see information about the next instruction.

Tap the button and select an option for when the map should be turned off. These are the options:

- **Always** - The map will not be shown and you will only see information about the next instruction and arrows showing direction.
- **Above a certain speed** - you set the speed at which point the map will be turned off. This option is useful for situations when the map might be distracting, such as when you are driving fast.
- **Never** - the map is never turned off.

## Turn off sound / Turn on sound



Turn off sound

Tap this button to turn off spoken instructions.

The button changes to **Turn on sound**. If you turn off the sound, warnings for upcoming POIs are also turned off.

---

### Tips

To change the volume, tap **Volume preferences** in the Preferences menu.

For more information, see **Volume preferences** (28).

To change the volume quickly while you are driving, tap the bottom left-hand section of the Driving View and move the slider.

To change the voice being used by your ONE, tap **Change voice** in the Preferences menu.

For more information, see **Selecting a voice** (14).

---

## Volume preferences

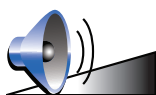

**Volume preferences**

Tap this button to change the volume for spoken instructions.

## Manage Favorites



**Manage Favorites**

Tap this button to rename or delete Favorites.

To find a Favorite quickly, tap **Find**, then start to type the name of the Favorite. As soon as the Favorite is shown in the list, you can select it.

For more information about Favorites, see **Favorites** (18).

## TomTom Safety Cameras



**TomTom Safety Cameras**

Tap this button to use TomTom Safety Cameras.

## Change voice



**Change voice**

Tap this button to change the voice that is used for announcing command directions.

For more information about Voices, see **Sounds and voices** (14).

## Warn when near POI



**Warn when near POI**

Tap this button to announce a warning when you are approaching a Point of Interest.

For more information about Points of Interest, see **Points of Interest** (23).

## Change Home location



**Change Home location**

Tap this button to set or change your Home location.

**Do I need to use my actual home address for the Home location?**

No. Your Home location can be a place you go often, for example, your office. It can be your actual home address, but it can also be any address you like.

### Why should I set a Home location?

Having a Home location means that you have a quick and easy way to navigate there, by tapping the Home button in the **Navigate to...** menu

## Manage maps



### Manage maps

Tap this button to do the following:

- **Download a map** - you can buy new maps using TomTom HOME.  
For more information, see **Using TomTom HOME** (43).
- **Switch map** - tap this button to change the map you are using.
- **Delete a map** - tap this button to delete a map. This might be necessary to create more space on your ONE, for example when you want to load a different map.

---

**Note:** *Don't delete a map unless you have already made a backup of the map. If you delete a map before you make a backup, you will no longer be able to load the map on your ONE.*

---

For more information about making a backup, see **Using TomTom HOME** (43).

You can also download, add and delete maps using TomTom HOME.

## Change 2D/3D display / Turn on 2D display



### Turn on 2D display

Tap **Turn on 2D display** to change the perspective for viewing the map.

For example, the 2D view shows a two dimensional view of the map as though viewed from above.



### Change 2D/3D display

To switch the view to a three dimensional perspective, tap **Change 2D/3D display** and select a view from the list.

### When should I use this?

In some situations, it is easier to see the map from above. Perhaps if the road network is complicated or for times when you are walking while using your ONE to navigate.

## Compass preferences



**Compass preferences**

Tap this button to configure the compass. The following options are available:

- **None** - the compass is not shown.
- **One with arrow pointing north** - the arrow always points towards north and the direction you are moving is shown at the top of the compass.
- **One with arrow showing your heading** - the arrow always shows the direction you are moving.

If you select one of these options, you then need to select the features that are shown in the middle of the arrow:

- **Direction** - your direction is shown as a compass point, displayed in the center of the compass arrow.
- **Degrees** - your direction is shown as compass degrees, displayed in the center of the compass arrow.
- **Nothing**
- **One with arrow pointing to your destination** - the arrow always points towards your destination. The distance to your destination is displayed in the compass arrow.

## Change map colors

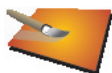

**Change map colors**

Tap this button to select the color schemes for day and night map colors.

You can also download more color schemes from TomTom PLUS.

## Brightness preferences



**Brightness preferences**

Tap this button to set the brightness of the screen.

You can set the brightness separately for day map colors and for night map colors.

You can set the map color scheme by tapping **Change map colors**. For more information, see **Change map colors (30)**.

## Status bar preferences



Status bar preferences

Tap this button to select the information shown on the status bar:

- **Remaining time** - the estimated time left until you reach your destination.
- **Remaining distance** - the distance left until you reach your destination.
- **Current time**
- **Arrival time** - your estimated arrival time.
- **Speed**
- **Direction**
- **Show next street name** - the name of the next street on your trip.
- **Show current street name**
- **Show leeway to arrival time** - your ONE shows how late or early you will be compared with the preferred arrival time that is set during the planning of a route.
- **Show max speed next to speed** - only available when speed (above) is also selected.
- **How should the status bar be displayed?**

**Horizontal** - If you choose this option, the status bar will be shown at the bottom of the Driving view.

**Vertical** - If you choose this option, the status bar will be shown at the right-hand side of the Driving view.

---

**Note:** *If the speed limit for the road you are on is available, it is shown next to your speed.*

*If you drive faster than the speed limit, your speed is shown in red.*

---

## Guided tours



Guided tours

Tap this button to show one of the Guided tours on how to use your TomTom ONE.

## Set units

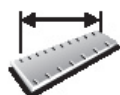

Set units

Tap this button to set the type of units that will be shown for the following:

- Distance
- Time
- Latitude and longitude
- Temperature
- Air pressure

## Operate left-handed / Operate right-handed



**Operate left-handed**

Tap this button to move important buttons, for example, the **Done** and **Cancel** buttons as well as the zoom bar, to the left hand side of the screen. This makes it easier to tap the buttons with your left hand without blocking the screen.

To move the buttons back to the right hand side of the screen, tap **Operate right-handed**.

## Keyboard preferences



**Keyboard preferences**

You use the keyboard to enter your destination or to find an item in a list, such as a POI.

Tap this button to select the size of the keys on the keyboard and the keyboard layout. You can select from two sizes:

- **Large keyboard**
- **Small keyboard**

Three keyboard layouts are available:

- **ABCD keyboard**
- **QWERTY keyboard**
- **AZERTY keyboard**

---

***Note:** The keyboard does not include accents of any kind for any language so you don't have to worry about entering letters with accents. Simply type the letter without the accent and your ONE will recognize the word.*

---

## Planning preferences



**Planning preferences**

Tap this button to set the kind of route planned when you select a destination.

The following options are available:

- **Ask me every time I plan**
- **Always plan fastest routes**
- **Always plan shortest routes**
- **Always avoid freeways**
- **Always plan walking routes**
- **Always plan bicycle routes**
- **Always plan for limited speed**

Then answer the following question:

**Do you want the route summary screen to close automatically after 10 seconds?**



## Set owner



**Set owner**

Tap this button to enter your name and address as the owner of your ONE and to change or delete a 4-digit password for your ONE.

---

**Note:** You can only change or delete a 4-digit password on your TomTom ONE.

---

You can create a 4-digit password for your ONE using TomTom HOME:

1. Connect your ONE to your computer and turn on your ONE and your computer.

TomTom HOME starts automatically.

For information about installing TomTom HOME on your computer, see **Installing TomTom HOME** (43).

2. From the Options menu in TomTom HOME, click My ONE.
3. Click the ON/OFF button on the picture of your ONE to start the application on your computer.
4. From the Main Menu, click **Change preferences**.
5. Click **Set Owner**. You can now set a 4-digit password for your ONE.

You can only create a 4-digit password using TomTom HOME.

## Change language



**Change language**

Tap this button to change the language used for all the buttons and messages you see on your ONE.

You can choose from a wide range of languages. When you change the language, you are also given the opportunity to change the voice.

## Set clock



**Set clock**

Tap this button to select the type of clock that is shown and set the time.

The easiest way to set the time is by tapping the **Sync** button. Your ONE will then take the time from GPS information.

For more information about GPS, see **Global Positioning System (GPS)** (42).

---

**Note:** After using **Sync** to set the time, you may have to adjust the hours depending on your time zone. Your ONE works out your time zone and always keeps the time correct using GPS information.

You can only use **Sync** if you have GPS reception, so you cannot set the clock in this way when you are indoors.

---

## Reset factory settings



**Reset factory  
settings**

Tap this button to restore the factory settings to your TomTom ONE.

All your settings, including Favorites, your Home location, warnings for POIs and any Itineraries you have created, as well as recent destinations and recent calls and callers, will be deleted.

## 12. Traffic information using RDS-TMC

---

### The Traffic Message Channel (TMC)

The Traffic Message Channel (TMC) is not a TomTom Service. FM radio stations in several countries broadcast TMC information as part of their programming. TMC is also known as RDS-TMC traffic information.

Your TomTom device uses this information to warn you about traffic delays along your route and how you can avoid them.

To use TMC traffic information, you need a TomTom RDS-TMC Traffic Receiver that comes with some TomTom devices or is available as an accessory for others. For more information on which TomTom devices support RDS-TMC receivers, visit [www.tomtom.com](http://www.tomtom.com).

---

***Note:** TomTom is not responsible for the availability or quality of traffic information provided by TMC.*

*TMC is not available in all countries or regions. Visit [www.tomtom.com](http://www.tomtom.com) to check if it is available in your country or region.*

---

### Setting up TMC

To start using TMC, all you need to do is connect the RDS-TMC Traffic Receiver to your TomTom device or to the windscreen mount of your TomTom device, depending on your product.

The receiver works best when mounted in a vertical position, so if possible, try to place your TomTom device towards the drivers side corner of the windscreen so that the receiver can be secured out side of your field of vision.

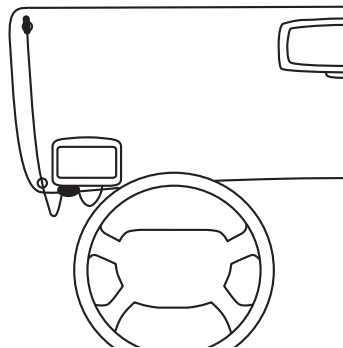

After you have finished positioning the receiver switch your TomTom device on. The Traffic sidebar is shown on the right-hand side of the Driving View and your device searches for a radio station that has RDS-TMC information.



The following symbols are shown at the top of the Traffic sidebar:



Your device is looking for a radio station with RDS-TMC traffic information.



Your device has found a suitable radio station and is checking for the latest traffic information.



Your device is tuned to a radio station and receives RDS-TMC traffic information when available.

---

**Tip:** The yellow circle is shown at the top of the Traffic sidebar if your device cannot find a suitable radio station. You can make your device try again to find a suitable station by tapping **Tune automatically** in the traffic menu. If you know the FM frequency of a station that broadcasts RDS-TMC traffic information, you can tune to it manually. For more information see **Setting the radio frequency for RDS-TMC information** (39).

---

## Using RDS-TMC traffic information



Your device receives traffic information when it is broadcasted.

If there are any incidents on your route the Traffic sidebar on the right side of the Driving View warns you. An example of a Traffic sidebar with a traffic warning is shown to the left. For information on the Traffic sidebar, see **The Traffic sidebar (39)**.

In the example on the left there is a traffic jam on your route with an expected delay of 38 minutes, 20 miles ahead of you. To find the quickest route to your destination, do the following:

1. Tap the Traffic sidebar.

---

**Tip:** If you have trouble tapping the Traffic sidebar and the Main Menu is being displayed instead of the traffic menu, try tapping your finger half on the Traffic sidebar and half off the screen.

---

2. Tap **Minimize traffic delays**.

Your device looks for the quickest route to your destination.

It is possible that the new route may also include traffic delays, or may even be the same route as before. You can re-plan the route to avoid all delays, but this new route will take longer than the quickest route already shown.

3. Tap **Done**.

---

**Tip:** It is possible to let your TomTom device automatically minimize traffic delays for you, to do this, see **Changing traffic preferences (37)**.

---

## Changing traffic preferences

Use the **Change Traffic preferences** button to choose how traffic information works on your device.



**Change  
Traffic  
preferences**

To change your traffic preferences, do the following:

1. Tap the TomTom**Traffic** button in the Main Menu on your device.
2. Tap **Change Traffic preferences**.

You can change the following preferences:

- **Automatically minimize delays after every traffic update** - if you select this option, your device automatically recalculates when new delays occur on your route.
- **Beep when traffic situation on route changes** - if you select this option your device beeps when a new traffic incident occurs on your current route.
- **Ask for traffic updates when preparing a route** - this option has no effect in RDS traffic.

3. Select or clear the check box next to each preference you want to change.

4. Tap **Done**.

Your device lists the countries that have radio stations providing RDS-TMC traffic information that you can currently receive. Normally you can leave this set to **Any country (strongest signal)**. For more information about this country setting, see **Choosing the correct country for RDS-TMC reception** (39).

5. Tap **Done**.

## Making commuting to work easier

The **Home to work** or **Work to home** buttons in the Traffic menu lets you check your route to and from work with one tap of a button. When you use either of these buttons, your device checks the route for possible delays, and if it finds any, provides you with the possibility to avoid them.

The first time you use **Home to work**, you must set your traffic home and work locations, do the following:



1. Tap the TomTom**Traffic** button in the Main Menu on your device.
2. Tap **Show home-work traffic**.
3. Tap **Change home-work**
4. Set your home location
5. Set your work location.

You can now use the **Home to work** and **Work to home** buttons of the Show home-work traffic menu.

For example, to check for delays on your route home, do the following:

1. Tap the TomTom**Traffic** button in the Main Menu on your device.
2. Tap **Show home-work traffic**.
3. Tap **Work to home**.

The route summary screen is shown.

To see if there is a quicker way home, you could now tap the **Find alternative** button and then tap **Minimize traffic delays**.

---

**Tip:** You can let your device automatically look for alternative routes by selecting **Automatically minimize delays after every traffic update** in your Traffic preferences. For more information, see **Changing traffic preferences** (37).

---

---

**Note:** It is possible that the alternative route could be longer than your original one (even with its delays). If this is the case, you could always try using the **Find alternative** button again.

---

## Setting the radio frequency for RDS-TMC information



If you know the frequency of a particular radio station you want to use for RDS-TMC traffic information, do the following to set the frequency manually:

1. Tap the Traffic sidebar in the Driving View.
2. Tap **Tune Manually**.
3. Enter the frequency of the radio station.
4. Tap **Done**.

Your TomTom device looks for your radio station. If it doesn't find a radio station at the frequency you set, it automatically continues to search for the next available station.

## Choosing the correct country for RDS-TMC reception

If you are driving close to a country border, your device may tune to a radio station from a neighboring country. If this happens you will only receive RDS-TMC traffic information for that country. To set the country you want to receive traffic information for, do the following:

1. Tap the Traffic sidebar in the Driving View.
2. Tap **Change Traffic preferences**.

A list of preferences you can choose is shown, these preferences are described in **Changing traffic preferences (37)**.

3. Tap **Done**.

A list of neighboring countries is shown.

4. Tap on the country that you want to receive traffic reports for.

Your TomTom device then searches for a radio station in the country you have chosen.

## The Traffic sidebar

The Traffic sidebar is shown on the right side of the Driving View when TomTom **Traffic** is switched on. The Traffic sidebar shows you the traffic incidents on your route. It shows the following information:

- A symbol for each traffic incident in the order they occur along your planned route.
- The estimated delay to the next traffic incident on your route.
- The distance from your current location to the next incident on your route.

An example of a Traffic sidebar is shown below.



In the example, the Traffic sidebar shows you that there are two incidents ahead. Both incidents are traffic jams, the first is 15 miles ahead and is expected to delay you by at least 51 minutes.

To re-plan your route to avoid these incidents, tap the Traffic sidebar to open the TomTom **traffic** menu, then use **Minimize traffic delays**. For more information see **Using RDS-TMC traffic information (37)**.

## Traffic incidents

Traffic incidents are displayed both on the Driving View and also on the Traffic sidebar as small symbols. There are two type of symbols:

- Symbols shown in a red square are incidents that Traffic can help you avoid.
- Symbols shown in a red rectangle are weather related, because of their nature, you cannot use Traffic to avoid them.

Traffic incident symbols and their meaning are shown below:



**Accident**



**Road closed**



**Road works**



**Traffic incident**



**One or more lanes closed**



**Traffic jam**

Weather related symbols and their meaning are shown below:



**Fog**



**Ice**



**Rain**



**Snow**



**Wind**



**Note:** The incident avoided symbol is shown for any traffic incident that you avoid using TomTom **Traffic**.



## Traffic menu

Tap the Traffic sidebar in the Driving View to open the Traffic menu. The following buttons are available:



**Minimize traffic delays**

Tap this button to re-plan your route based on the latest traffic information.



**Tune automatically**

Tap this button to get your device to automatically search for a radio frequency that carries RDS-TMC traffic information.

***Note:** Your TomTom device automatically searches for a suitable radio station, use this button to force your device to search for the next suitable station.*

---



**Tune manually**

Tap this button to get your device to tune to a specific radio frequency that carries RDS-TMC traffic information.

See **Setting the radio frequency for RDS-TMC information (39)**.



**Show traffic on route**

Tap this button to show areas of traffic congestion along your current route.



**Show home-work traffic**

Tap this button to calculate and show the quickest route from your home location to your place of work and back.

See **Making commuting to work easier (38)**.



**Change Traffic preferences**

Tap this button to change your preferences for how TomTom **Traffic** works on your device.

See **Changing traffic preferences (37)**.

---

## 13. How Does Navigation Work?

---

### Global Positioning System (GPS)

In order to navigate you to your destination, your TomTom ONE must know where you are now. To find your current position, your ONE uses the Global Positioning System (GPS). GPS is available for free and without subscription.

GPS uses satellites to transmit signals to GPS receivers. Your TomTom ONE has a built-in GPS receiver. Using the GPS signal, your ONE can work out where you are and how fast you are going. GPS signals work in all weather, anywhere in the world.

---

**Note:** *Your TomTom ONE does not transmit your position, so others cannot use it to track you while you are driving.*

---

### Maps

Once your TomTom ONE knows where you are and you have told it where you want to go, it uses the digital map on the memory card or hard disk to work out the best route to your destination.

## 14. Using TomTom HOME

---

TomTom HOME is a free software program for your computer that enables you to:

- Manage maps, voices, POIs and more.
- Buy TomTom services and manage your subscriptions.
- Update your TomTom with the latest software and services automatically.
- Make and restore backups.
- Set a password to restrict access.
- Read the full version of the user manual.

### Installing TomTom HOME

Install TomTom HOME on your computer in the following way.

- Connect your computer to the Internet and then connect your TomTom ONE to your computer using the USB cable.

A pop-up window appears. Select **Run** TomTom HOME. Click **OK** and follow the on-screen instructions.

If the pop-up window does not appear, browse to the TomTom device on your computer and run the file named **Install** TomTom HOME.

- TomTom HOME is also available for download from the TomTom Web site.

For more information visit [www.tomtom.com/home](http://www.tomtom.com/home)

Once installed, TomTom HOME will start automatically whenever you connect your TomTom to your computer.

### HOME Help Topics

In the TomTom HOME Help topics you can find all kinds of tips and tricks on how to use TomTom HOME.

### MyTomTom Account

In order to buy content and services through TomTom HOME you will have to set up a MyTomTom account for the device you want to buy the content for. You will be asked to create an account when you start using TomTom HOME.

## 15. TomTom Limited Warranty

---

### WARRANTOR

U.S. and Canadian Purchases: If you have made your purchase in the United States or Canada, this Limited Warranty is granted by and this Limitation of Liability is stipulated for the benefit of TomTom Inc., 150 Baker Avenue Extension, Concord Massachusetts 01742 (United States of America).

### WHAT THIS WARRANTY COVERS

1) TomTom Inc. ("TomTom") warrants to the original purchaser ("you") of the hardware with which this Limited Warranty is included ("Hardware") that the Hardware will be free from defects in workmanship and materials under normal use ("Defects") for a period of one (1) year from the date that the Hardware was first purchased by you ("Warranty Period"). During the Warranty Period the Hardware will be repaired or replaced at TomTom's choice ("Limited Warranty") without charge to you for either parts or labour. This Limited Warranty covers the replacement of the Hardware only. If the Hardware is repaired after the Warranty Period has expired, the Warranty Period for the repair will expire six (6) months after the date of repair.

### WHAT THIS WARRANTY DOES NOT COVER

2) The Limited Warranty does not apply to normal wear and tear, does not apply when the Hardware is opened or repaired by someone not authorized by TomTom and does not cover repair or replacement of any Hardware or part thereof damaged by: misuse, moisture, liquids, proximity or exposure to heat and accident, abuse, non-compliance with the instructions supplied with the Hardware, neglect or misapplication. The Limited Warranty does not cover physical damage to the surface of the Hardware. This Limited Warranty does not cover any software that may accompany or be installed on the Hardware. The Limited Warranty does not cover the installation, removal or maintenance of the Hardware or any costs related herewith.

### HOW TO MAKE A WARRANTY CLAIM

3) In order to make a claim of a Defect, you must contact TomTom during the Warranty Period at: 1-978-287-9555 or per email via [www.tomtom.com](http://www.tomtom.com) to explain the Defect and to obtain an RMA number (Return Materials Authorization) if necessary. You must return the Hardware during the Warranty Period, along with an explanation of the Defect, to the address provided to you by TomTom. If a defect arises and a valid claim under this Limited Warranty is received by TomTom after the first one hundred and eighty (180) days of the Warranty Period, TomTom is entitled to charge you for any reasonable shipping and handling costs made in connection with the repair or replacement of the Hardware. You must comply with any other return procedures stipulated by TomTom, if any.

## YOUR LEGAL RIGHTS

- 4) This Limited Warranty gives you specific legal rights, and you may also have other rights which vary from state to state and jurisdiction to jurisdiction.
- 5) If any part of this Limited Warranty is held to be invalid or unenforceable, the remainder of the Limited Warranty shall nonetheless remain in full force and effect.
- 6) This Limited Warranty is the only express warranty made to you and is provided in lieu of any other express warranties or similar obligations (if any) created by any advertising, documentation, packaging, or other communications.
- 7) Except for the Limited Warranty and to the maximum extent permitted by applicable law, TomTom and its suppliers provide the Hardware "AS IS AND WITH ALL FAULTS", and hereby disclaim all other warranties and conditions, whether express, implied or statutory, including, but not limited to, any (if any) implied warranties, duties or conditions of: merchantability, non-infringement, quiet enjoyment, system integration, satisfactory quality, fitness for a particular purpose, reliability or availability, accuracy or completeness of responses, results, workmanlike effort, lack of viruses, and reasonable care and skill, all with regard to the Hardware, and the provision of or failure to provide support or other services, information, software, and related content through the Hardware or otherwise arising out of the use of the Hardware. This exclusion does not apply to (i) any implied condition as to title and (ii) any implied warranty as to conformity with description. If applicable law requires any implied warranties with respect to the Hardware, all such warranties are limited in duration to ninety (90) days. Some states and/or jurisdictions do not allow limitations on how long an implied warranty lasts, so the above may not apply to you.
- 8) This Limited Warranty cannot be transferred to any other person.

## LIMITATION OF LIABILITY

- 9) Neither TomTom nor its suppliers shall be liable to you or to any third party for any indirect, incidental, consequential, special or exemplary damages (including in each case, but not limited to, damages for the inability to use the equipment or access data, loss of data, loss of business, loss of profits, business interruption or the like) arising out of the use of or inability to use the Hardware even if TomTom has been advised of the possibility of such damages.
- 10) Notwithstanding any damages that you might incur for any reason whatsoever (including, without limitation, all damages referenced herein and all direct or general damages in contract or anything else), the entire liability of TomTom and any of its suppliers shall be limited to the amount actually paid by you for the Hardware.
- 11) Notwithstanding the above, neither party's liability for death or personal injury resulting from its own negligence shall be limited.
- 12) Some states and/or jurisdictions do not allow the exclusion or limitation of incidental or consequential damages, so the above limitations or exclusions may not apply to you.

## 16. Addendum

---

### Important Safety Notices and Warnings

#### Global Positioning System

The Global Positioning System (GPS) is a satellite-based system that provides location and timing information around the globe. GPS is operated and controlled under the sole responsibility of the Government of the United States of America which is responsible for its availability and accuracy. Any changes in GPS availability and accuracy, or in environmental conditions, may impact the operation of your TomTom device. TomTom does not accept any liability for the availability and accuracy of GPS.

#### Use with Care

Use of a TomTom device for navigation still means that you need to drive with due care and attention.

#### Aircraft and Hospitals

Use of devices with an antenna is prohibited on most aircraft, in many hospitals and in many other locations. A TomTom device must not be used in these environments.

#### Battery

This product uses a Lithium-Polymer battery. Do not use it in a humid, wet and/or corrosive environment. Do not put, store or leave your product in or near a heat source, in a high temperature location, in strong direct sunlight, in a microwave oven or in a pressurized container, and do not expose it to temperatures over 60 C (140 F). Failure to follow these guidelines may cause the Lithium-Polymer battery to leak acid, become hot, explode or ignite and cause injury and/or damage. Do not pierce, open or disassemble the battery. If the battery leaks and you come into contact with the leaked fluids, rinse thoroughly with water and seek medical attention immediately. For safety reasons, and to prolong the lifetime of the battery, charging will not occur at low (below 0 C/32 F) or high (over 45 C/113 F) temperatures.

Temperatures: Standard operation: -10 C (14 F) to +55 C (131 F); short period storage: -20 C (-4 F) to + 60 C (140 F); long period storage: -20 C (-4 F) to +25 C (77 F).



THE LITHIUM-POLYMER BATTERY CONTAINED IN THE PRODUCT MUST BE RECYCLED OR DISPOSED OF PROPERLY. USE YOUR TomTom ONLY WITH THE SUPPLIED DC POWER LEAD (CAR CHARGER/BATTERY CABLE) AND AC ADAPTER (HOME CHARGER) FOR BATTERY CHARGING.

To recycle your TomTom unit please see your local approved TomTom service center.

## **SPECIAL NOTE REGARDING DRIVING IN CALIFORNIA AND MINNESOTA**

California Vehicle Code Section 26708 (a) (1) provides that "No persons shall drive any motor vehicle with an object or material placed, displayed, installed, affixed or applied upon the windshield or side or rear windows." Drivers in California should not use a suction mount on their windshield, side or rear windows.

Note: this section of the California Vehicle Code applies to anyone driving in California, not just California residents.

Minnesota State Legislature Statutes Section 169.71, subdivision 1, section 2 provides that "A person shall not drive or operate with any objects suspended between the driver and the windshield other than sun visors and rearview mirrors and electronic toll collection devices."

Note: this Minnesota Statute applies to anyone driving in Minnesota, not just Minnesota residents.

TomTom Inc. bears no responsibility for any fines, penalties or damage that may be incurred by disregarding this notice. While driving in any state with windshield mounting restrictions, TomTom recommends the use of the supplied Adhesive Mounting Disk or its Alternative Mounting Kit, which includes multiple options for mounting TomTom devices on the dashboard and using the air vents. See [www.tomtom.com](http://www.tomtom.com) for more information about this mounting option.

## **FCC Information for the User**



This product contains a transmitter which must not be co-located or simultaneously operated in conjunction with any other transmitter.

### **Exposure to Radio Frequency Radiation**

This device complies with FCC radiation exposure limits set forth for an uncontrolled environment. In order to avoid the possibility of exceeding the FCC radio frequency exposure limits, human proximity to the antenna shall not be less than 20cm (8 inches) during normal operation.

### **Radio and Television Interference**

This equipment radiates radio frequency energy and if not used properly - that is, in strict accordance with the instructions in this manual - may cause interference to radio communications and television reception.

This device has been tested and found to comply with the limits for a Class B digital device, pursuant to Part 15 of the FCC Rules. These limits are designed to provide reasonable protection against harmful interference in a residential installation. This equipment generates, uses and can radiate radio frequency energy and, if not installed and used in accordance with the instructions, may cause harmful interference to radio communications. However, there is no guarantee that interference will not occur in a particular installation. If this equipment does cause harmful interference to radio or television reception, which can be determined by turning the equipment off and on, the user is encouraged to try to correct the interference by one or more of the following measures:

- Reorient or relocate the receiving antenna.
- Increase the separation distance between the equipment and the receiver.
- Connect the equipment into an outlet on a circuit different from that to which the receiver is connected.
- Consult an experienced radio/TV technician for help.

Changes or modifications not expressly approved by the party responsible for compliance could void the user's authority to operate the equipment.

## Important

This equipment was tested for FCC compliance under conditions that included the use of shielded cables and connectors between it and the peripherals. It is important that you use shielded cable and connectors to reduce the possibility of causing radio and television interference. Shielded cables, suitable for the product range, can be obtained from an authorised dealer. If the user modifies the equipment or its peripherals in any way, and these modifications are not approved by TomTom, the FCC may withdraw the user's right to operate the equipment. For customers in the USA, the following booklet prepared by the Federal Communications Commission may be of help: "How to Identify and Resolve Radio-TV Interference Problems". This booklet is available from the US Government Printing Office, Washington, DC 20402. Stock No 004-000-00345-4.

## FCC Declaration of Conformity

### Tested to Comply with FCC Standards for Home or Office Use

This device complies with part 15 of the FCC Rules. Operation is subject to the following two conditions:

1. This device may not cause harmful interference.
2. This device must accept any interference received, including interference that may cause undesired operation.

### Responsible party in North America

TomTom, Inc., 150 Baker Avenue, Concord, MA 01742

Tel: 866 486-6866 option 1 (1-866-4-TomTom)

### Emissions information for Canada

This Class B digital apparatus complies with Canadian ICES-003. Cet appareil numérique de la classe B est conforme à la norme NMB-003 du Canada.

## C-tick



**N14644**

This product displays the C-tick to show it complies with all relevant Australian and New Zealand regulations.

## Warning for Australia

The user needs to switch off the device when exposed to areas with potentially explosive atmospheres such as petrol stations, chemical storage depots and blasting operations.

## This Document

Great care was taken in preparing this manual. Constant product development may mean that some information is not entirely up-to-date. The information in this document is subject to change without notice.

TomTom shall not be liable for technical or editorial errors or omissions contained herein; nor for incidental or consequential damages resulting from the performance or use of this material. This document contains information protected by copyright. No part of this document may be photocopied or reproduced in any form without prior written consent from TomTom International B.V.

### Part numbers



TomTom ONE: 4N01.000, 4N01.001, 4N01.002, 4N01.003

## 17. Copyright notices

---

---

© 2007 TomTom International B.V., The Netherlands.

*Patents Pending. All rights reserved.*

*TomTom and the TomTom logo are registered trademarks of TomTom International B.V., The Netherlands. All other trademarks are the property of their respective owners.*

*Our end user license agreement and a limited warranty apply to this product; they are included in this package. You can also review both at [www.TomTom.com/legal](http://www.TomTom.com/legal)*

---

---

*Data Source*

© 1984 – 2007 Tele Atlas North America, Inc. All rights reserved.

*Canadian data © DMTI Spatial. Portions of Canadian map data are reproduced under license from Her Majesty the Queen in Right of Canada with permission from Natural Resource Canada. Point of Interest data by Info USA. Copyright 2007.*

---

---

*Some images are taken from NASA's Earth Observatory.*

*The purpose of NASA's Earth Observatory is to provide a freely-accessible publication on the Internet where the public can obtain new satellite imagery and scientific information about our home planet.*

*The focus is on Earth's climate and environmental change:  
[earthobservatory.nasa.gov/](http://earthobservatory.nasa.gov/)*

---